

C-Rail Festoon track systems

Cable & Hose carrying systems



Application

C-Rail festoon track systems are the ideal solution for carrying cables supplying power to many types of moving machinery using either flat or round cables, typical uses include power feeds to hoists, factory cranes and pendant control systems. They can also be used to carry hoses for air, water, etc. A complete range of standard fittings is available for these systems along with a comprehensive selection of trolleys with carrying capacities up to 40kg / trolley. Standard track and components are manufactured from zinc plated steel and are suitable for the majority of industrial applications, where extra protection is required most components can be supplied with a polyester / epoxy coating and for extreme applications Stainless Steel track and components are also available. C-Rail festoon systems are also available for Ex rated Hazardous areas classified in Group 1 & 2 (Gas) & Group 21 & 22 (Dust) – details of these systems are shown later on in this section.

System Calculations (see drawing opposite)

System (Track size) selection

System 2331 – max cable stack = 58mm x 20mm, max trolley load = 20kg

System 2500 – max cable stack = 115mm x 50mm, max trolley load = 40kg

Cable Length

For correct installation the cable should never be pulled tight, we therefore recommend a 20% surplus be added to the overall track length, the calculation for cable length is shown below :

Total cable length = (overall track length x 1.2) + required tail lengths.

<i>Example</i>	Overall track length =15m
	Tail at Hoist end = 0.50m
	Tail at Feed end = 3m
	Total cable length = (15 x 1.2) + 0.5 + 3 = 21.5m

Number of Trolleys

The number of trolleys required in the system is determined by the cable loop depth, so using the information above we can calculate the number of trolleys

Required as follows :

No. of trolleys = [(overall track length x 1.2) / (2 x Loop depth)] - 1

<i>Example</i>	Overall track length =15m
	Loop depth = 0.75m
	No. of Trolleys = [(15 x 1.2) / (2 x 0.75)] - 1 = 11
	In addition you require 1 x Tow Trolley & 1 X End Anchor

Trolley selection

The correct trolleys should be selected by referring to the maximum cable stack, and maximum cable weight information shown on the trolley information on the following pages, maximum recommended cable stacks are calculated to ensure that trolley bodies will come together before the loops of cable clash or foul each other.



C-Rail Festoon track systems

Cable & Hose carrying systems

Parking Distance (see below)

The parking distance is the section of track taken up by the trolleys when collected together at the end of the system, this is a simple calculation determined by the number and type of trolleys.

Example	Overall track length = 15m
	Loop depth = 0.75m
	Trolley type 2401-5 (80mm body length)
	Tow trolley 2401-6 (80mm body length)
	Cable end anchor 2331-2 (80mm body length)
	No. of trolleys = 11
	Parking distance = 80 + (11 x 80) + 80 = 1040mm

Festoon Track Assembly

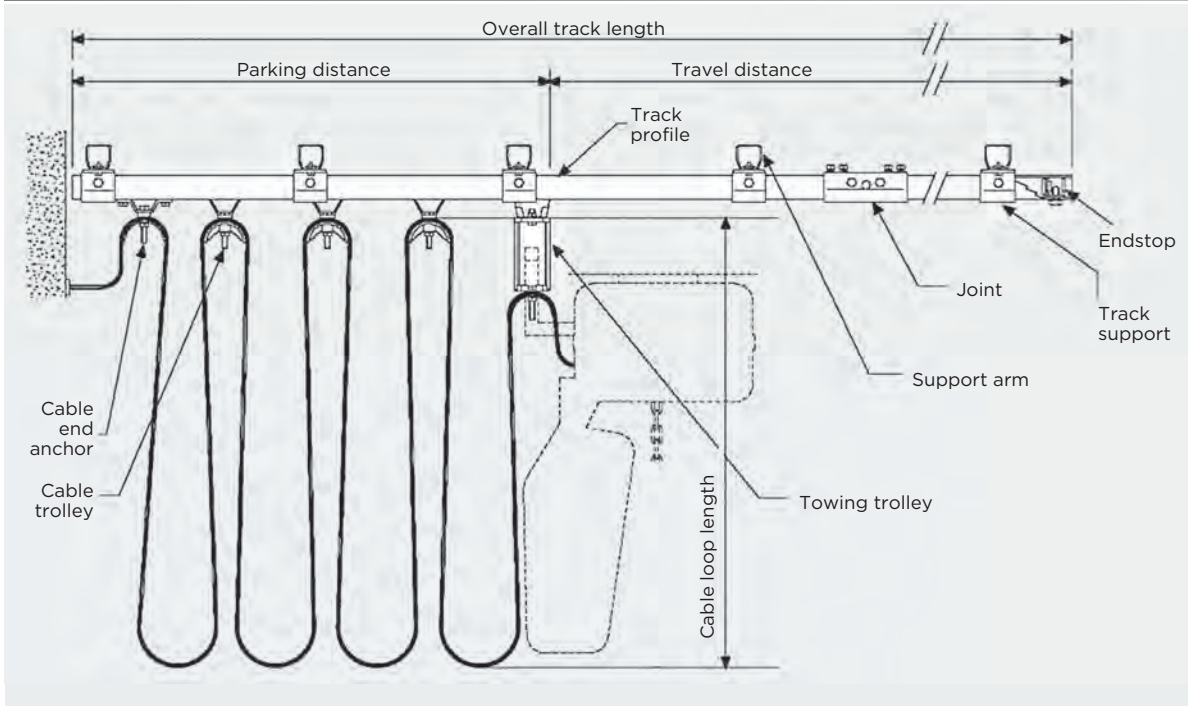

Installation

Installation of the C-Rail festoon system is very straightforward and can easily be carried out by a team of two accomplished installation engineers. Support centres (as shown below) are 1667mm for system 2331 (5m Lengths) and 1500mm for systems 2500/400 (3m/6m Lengths). A support should always be included within 300mm of a track joint as indicated. A variety of supports & support brackets are available and are detailed on the following pages.

Track Support Details

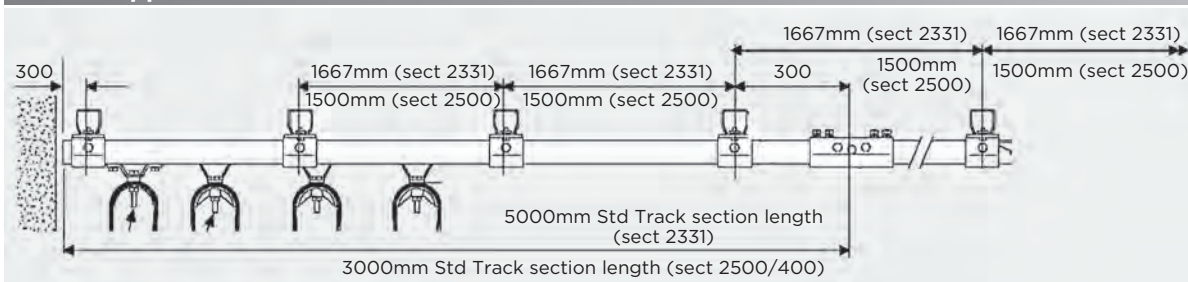

System 2331 C-Rail Festoon Track System

30 x 28mm C-Rail Cable & Hose carrying system

Track Profile

Part Code	Standard Length	Weight kg/m	Finish
2331-1	5 metres	1.32	Galv. Steel
2331-1-SS	5 metres	1.45	Stainless Steel

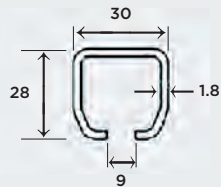

Standard Profile Length = 5 Metres

Single Stud Support

Part Code	Finish	For use with
2331-A-4-R	Zinc Plated Steel	Galv. Steel Track
2331-A-4-R-PLY	Zinc Plated Steel+Red Polyester/Epoxy Finish	Galv. or Stainless Steel Track

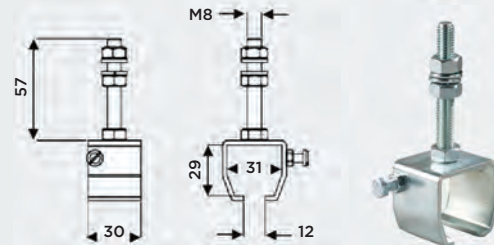

Ceiling Support (Preferred)

Part Code	Finish	For use with
2331-4A	Zinc Plated Steel	Galv. Steel Track
2331-4-A-PLY	Zinc Plated Steel+Red Polyester/Epoxy Finish	Galv. or Stainless Steel Track

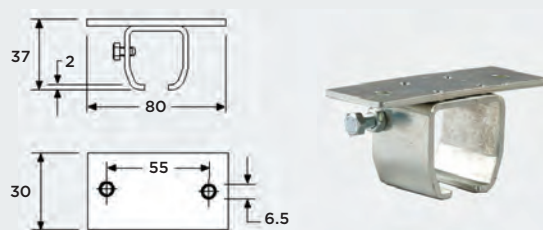

Ceiling Support (Optional)

Part Code	Finish	For use with
2331-4	Zinc Plated Steel	Galv. Steel Track
2331-4-PLY	Zinc Plated Steel+Red Polyester/Epoxy Finish	Galv. or Stainless Steel Track
2331-4-SS	Stainless Steel	Stainless Steel Track

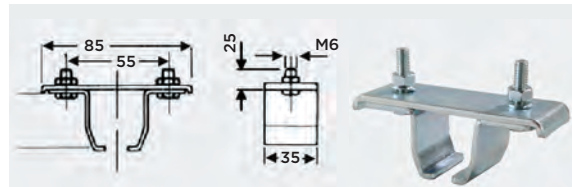

Track Support

Part Code	Finish	For use with
2331-13-31-31	Zinc Plated Steel	Galv. Steel Track
2331-13-31-31-PLY	Zinc Plated Steel+Red Polyester/Epoxy Finish	Galv. or Stainless Steel Track

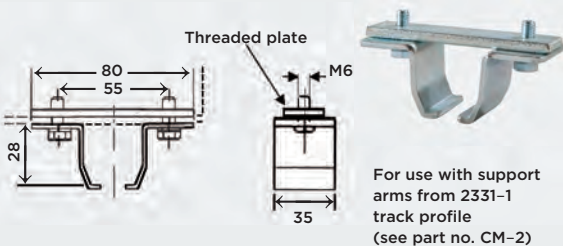

Beam Clip

Part Code	Finish	For use with
2340-12	Zinc Plated Steel	Galv. Steel Track
2340-12-PLY	Zinc Plated Steel+Red Polyester/Epoxy Finish	Galv. or Stainless Steel Track



Support Arm

Part Code	Finish	For use with
CM-2-500	Zinc Plated Steel	Galv./Stainless Steel Track

Support arm complete for 2331-1 track profile consists of:-

- 2 x Beam clip 2340-12
- 1 x Track support 2340-13-31-31
- 1 x 500mm length 2331-1 profile

For special lengths substitute required length 'L' for '500' in the part no. e.g. for L = 750mm, part no = CM-2-750

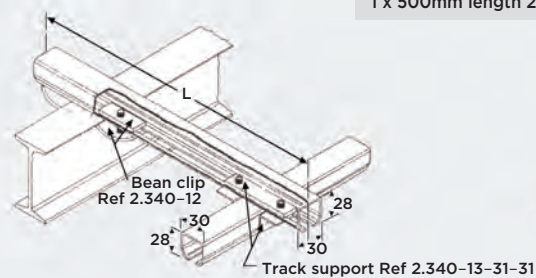

System 2331

30 x 28mm C-Rail Cable & Hose carrying system

Track Joint (Preferred)

Part Code	Finish	For use with
2331-3-E	Zinc Plated Steel	Galv. Steel Track
2331-3-E-PLY	Zinc Plated Steel+Red Polyester/Epoxy Finish	Galv. or Stainless Steel Track

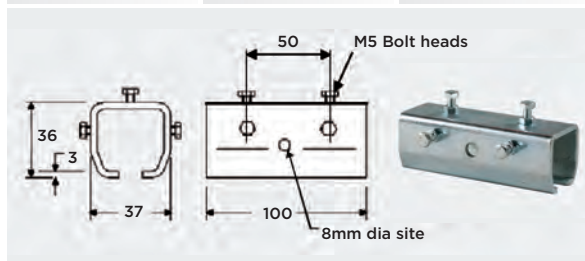

Track Joint (Optional)

Part Code	Finish	For use with
2331-3	Zinc Plated Steel	Galv. Steel Track
2331-3-PLY	Zinc Plated Steel+Red Polyester/Epoxy Finish	Galv. or Stainless Steel Track
2331-3-SS	Stainless Steel	Stainless Steel Track

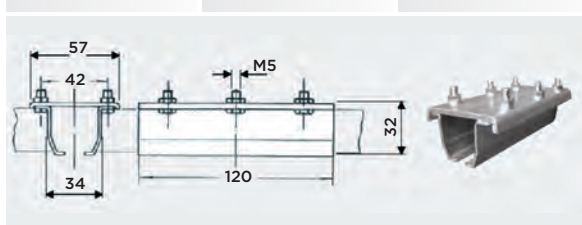

Endstop

Part Code	Finish	For use with
2309-2	Zinc Plated Steel	Galv. Steel Track
2309-2-PLY	Zinc Plated Steel+Red Polyester/Epoxy Finish	Galv. or Stainless Steel Track

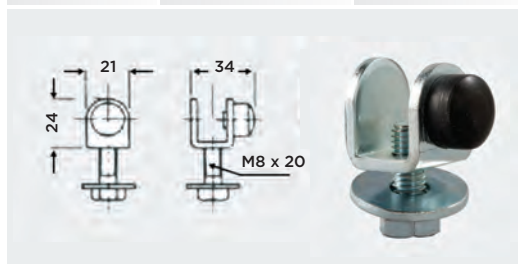

Cable Clamp

Part Code	Max Cable Width
B-58	58mm
B-65	65mm
B-90	90mm
B-117	117mm

Other sizes available on request

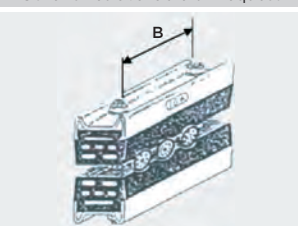

Welded Beam Fixing Clamp

Part Code	Finish	Use with
2600-120	Galv. Steel	2500 Arms

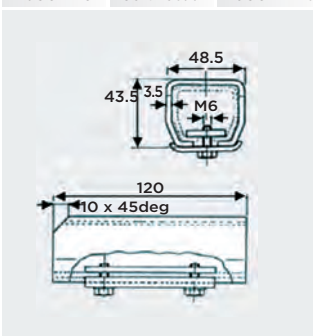

Cable Trolley

Part Code	Body	Wheels & Axles	Cable Clip	For use with
2401-5	Zinc Plated Steel	Zinc Plated Steel	Poly-propylene	Galv. Steel Track
2401-5-PLY	Zinc Plated Steel+Red Polyester/Epoxy Finish	Stainless Steel	Poly-propylene	Galv. or Stainless Steel Track

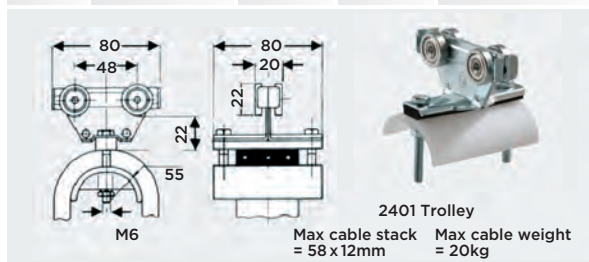

Cable Trolley

Part Code	Body	Wheels & Axles	Cable Clip	For use with
2401-C-5	Zinc Plated Steel	Zinc Plated Steel	Zinc Plated Steel	Galv. Steel Track
2401-C-5-PLY	Zinc Plated Steel+Red Polyester/Epoxy Finish	Stainless Steel	Zinc Plated Steel+Red Polyester/Epoxy Finish	Galv. or Stainless Steel Track
2401-CH-5-SS	Stainless Steel	Stainless Steel	Stainless Steel	Stainless Steel Track

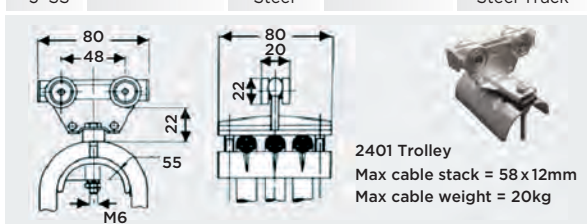

Cable Trolley (Long body)

Part Code	Body	Wheels & Axles	Cable Clip	For use with
2400-5	Zinc Plated Steel	Zinc Plated Steel	Poly-propylene	Galv. Steel Track
2400-5-PLY	Zinc Plated Steel+Red Polyester/Epoxy Finish	Stainless Steel	Poly-propylene	Galv. or Stainless Steel Track

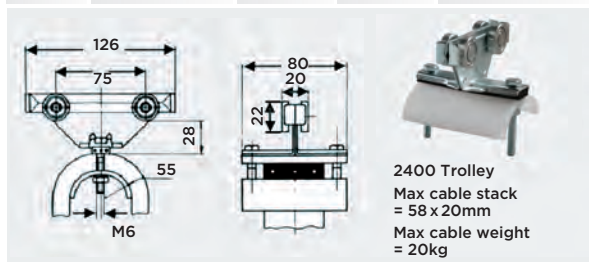

Cable Trolley (Long body)

Part Code	Body	Wheels & Axles	Cable Clip	For use with
2400-C-5	Zinc Plated Steel	Zinc Plated Steel	Zinc Plated Steel	Galv. Steel Track
2400-C-5-PLY	Zinc Plated Steel+Red Polyester/Epoxy Finish	Stainless Steel	Zinc Plated Steel+Red Polyester/Epoxy Finish	Galv. or Stainless Steel Track

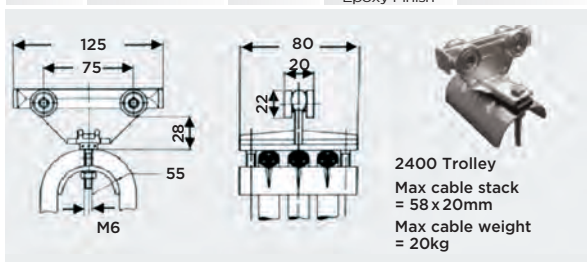

System 2331

30 x 28mm C-Rail Cable & Hose carrying system



Towing Trolley

Part Code	Body	Wheels & Axles	Cable Clip	For use with
2401-6	Zinc Plated Steel	Zinc Plated Steel	Poly-propylene	Galv. Steel Track
2401-6-PLY	Zinc Plated Steel+Red Polyester/Epoxy Finish	Stainless Steel	Poly-propylene	Galv. or Stainless Steel Track

2401 Trolley
Max cable stack = 58 x 12mm
Max cable weight = 20kg

Towing Trolley

Part Code	Body	Wheels & Axles	Cable Clip	For use with
2401-C-6	Zinc Plated Steel	Zinc Plated Steel	Zinc Plated Steel	Galv. Steel Track
2401-C-6-PLY	Zinc Plated Steel+Red Polyester/Epoxy Finish	Stainless Steel	Zinc Plated Steel+Red Polyester/Epoxy Finish	Galv. or Stainless Steel Track
2401-CH-6-SS	Stainless Steel	Stainless Steel	Stainless Steel	Stainless Steel Track

2401 Trolley
Max cable stack = 58 x 12mm
Max cable weight = 20kg



Towing Trolley (Long body)

Part Code	Body	Wheels & Axles	Cable Clip	For use with
2400-6	Zinc Plated Steel	Zinc Plated Steel	Poly-propylene	Galv. Steel Track
2400-6-PLY	Zinc Plated Steel+Red Polyester/Epoxy Finish	Stainless Steel	Poly-propylene	Galv. or Stainless Steel Track

2400 Trolley
Max cable stack = 58 x 20mm
Max cable weight = 20kg

Towing Trolley (Long body)

Part Code	Body	Wheels & Axles	Cable Clip	For use with
2400-C-6	Zinc Plated Steel	Zinc Plated Steel	Zinc Plated Steel	Galv. Steel Track
2400-C-6-PLY	Zinc Plated Steel+Red Polyester/Epoxy Finish	Stainless Steel	Zinc Plated Steel+Red Polyester/Epoxy Finish	Galv. or Stainless Steel Track

2400 Trolley
Max cable stack = 58 x 20mm
Max cable weight = 20kg

Cable End Anchor

Part Code	Body	Cable Clip	For use with
2331-2	Zinc Plated Steel	Polypropylene	Galvanised Steel Track
2331-2-PLY	Zinc Plated Steel+Red Polyester/Epoxy Finish	Polypropylene	Galv. or Stainless Steel Track

2331 Anchor
Max cable stack = 58 x 20mm
Max cable weight = 20kg

Cable End Anchor

Part Code	Body	Cable Clip	For use with
2331-C-2	Zinc Plated Steel	Zinc Plated Steel	Galvanised Steel Track
2331-C-2-PLY	Zinc Plated Steel+Red Polyester/Epoxy Finish	Zinc Plated Steel+Red Polyester/Epoxy Finish	Galv. or Stainless Steel Track
2331-C-2-SS	Stainless Steel	Stainless Steel	Stainless Steel Track

2331 Anchor
Max cable stack = 58 x 20mm
Max cable weight = 20kg

System 2331

30 x 28mm C-Rail Cable & Hose carrying system

Pendant Trolley (Plug & Socket)

Part Code	Body & Plate	Wheels & Axles	Cable Gland	Cable Clip	For use with
2301-7-10	Zinc Plated Steel	Zinc Plated Steel	Polyamide	Polypropylene	Galvanised Steel Track
2301-7-16	Zinc Plated Steel	Zinc Plated Steel	Polyamide	Polypropylene	Galvanised Steel Track
2301-7-24	Zinc Plated Steel	Zinc Plated Steel	Polyamide	Polypropylene	Galvanised Steel Track

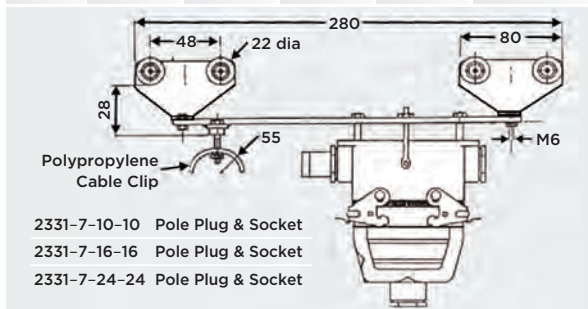

Pendant Trolley (Plug & Socket)

Part Code	Body & Plate	Wheels & Axles	Cable Gland	Cable Clip	For use with
2301-7-C-10	Zinc Plated Steel	Zinc Plated Steel	Polyamide	Zinc Plated Steel	Galvanised Steel Track
2301-7-C-16	Zinc Plated Steel	Zinc Plated Steel	Polyamide	Zinc Plated Steel	Galvanised Steel Track
2301-7-C-24	Zinc Plated Steel	Zinc Plated Steel	Polyamide	Zinc Plated Steel	Galvanised Steel Track

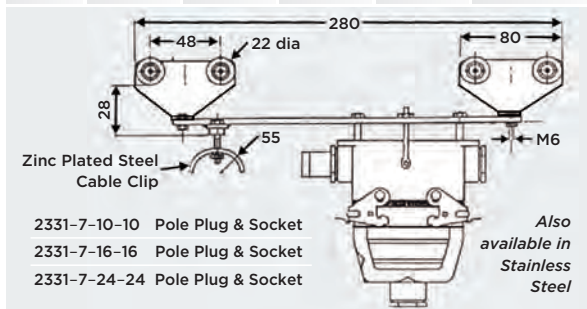

4 Wheel Curtain Trolley

Part Code	Body	Wheels & Axles	For use with
2330-D-22	Zinc Plated Steel	Zinc Plated Steel	Galvanised Steel Track
2330-D-22-SS	Stainless Steel	Stainless Steel	Stainless Steel Track

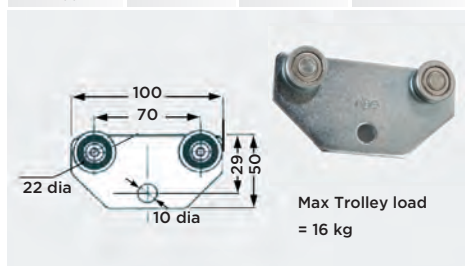

2 Wheel Curtain Trolley

Part Code	Body	Wheels & Axles	For use with
2330-22	Zinc Plated Steel	Zinc Plated Steel	Galvanised Steel Track
2330-22-SS	Stainless Steel	Stainless Steel	Stainless Steel Track

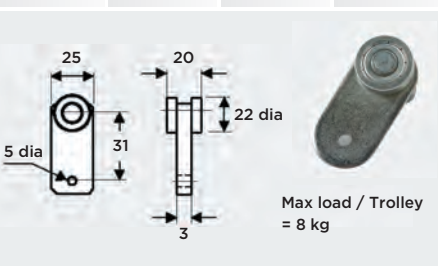

'S' Hook

Part Code
S-35

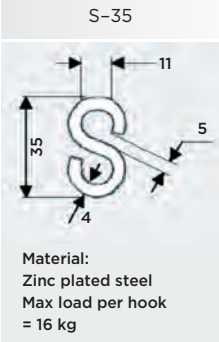

Round Cable / Hose Trolleys

Part Code	Item	Body	Wheels & Axles	For use with
2338-5	Trolley	Zinc Plated Steel	Zinc Plated Steel	Galv. Steel Track
2338-2	End Anchor	Zinc Plated Steel	N/A	Galv. Steel Track
2338-6	Tow Trolley	Zinc Plated Steel	Zinc Plated Steel	Galv. Steel Track

